

SU10 Commercial Centre Pole Umbrella



- Commercial grade aluminium frame structure
- Stainless steel hardware for longevity
- Durable high performance hub and fittings
- Telescopic mast enables umbrella to clear most furniture when closing
- Removable open/close handle
- Robust 82.5mm diam. mast with 3.4mm wall thickness
- Protection cover included
- Premium 100% solution dyed Acrylic canvas fabric canopy (UPF 50+)

FIXING OPTIONS

- In-ground Anchor
 Surface Plate
 Portable Base

FABRIC COLOURS



BLACK



OYSTER
WHITE



CHARCOAL
TWEED



LOGO RED



OCEAN BLUE



SUNFLOWER
YELLOW

Note - Huge range of custom colours available (surcharge will apply) 

WARRANTY**



*Conditions Apply



SIZES

OCTAGON

5.0m

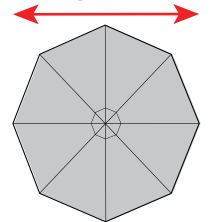

19m² coverage

SQUARE

4.0m

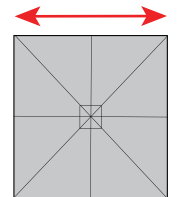

16m² coverage

5.0m

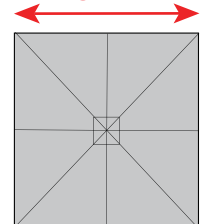

25m² coverage

SU10 Commercial Centre Pole Umbrella

DIMENSIONS:



Size	A. Hub Height	B. Arms Height	C. Canopy Width	D. Overall Height (opened)	E. Winder Handle Height	F. Closed Canopy Clearance	G. Overall Height (when closed)
4.0m / 13'1" Square	2.11m / 6'9"	2.27m / 7'5"	4.0m / 13'	2.87m / 9'4"	0.84m / 2'8"	0.90m / 3'0"	3.74m / 12'3"
5.0m / 16'4" Square	2.06m / 6'8"	2.27m / 7'5"	5.0m / 16'4"	2.92m / 9'6"	0.72m / 2'4"	0.53m / 1'7"	4.08m / 13'4"
5.0m / 16'4" diam Octagon	2.15m / 7'1"	2.27m / 7'5"	4.6m / 15'2"	2.81m / 9'2"	0.84m / 2'8"	1.04m / 3'4"	3.53m / 11'6"

NOTE: All measurements are rounded and are subject to change.

SU10 MAST & STRUT ARMS:

50x25mm / 2"x1"



Strut Arm

- Mast Size: 82mm / 3 1/4" diam
- Mast Wall Thickness: 3.4mm / 1/10"
- Strut Arm Size: 50x25mm / 2"x1"
- Strut Arm Wall Thickness: 3.2mm / 1/8"

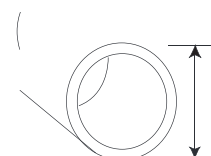

Mast

82mm / 3 1/4"

INSTALLATION OPTIONS:

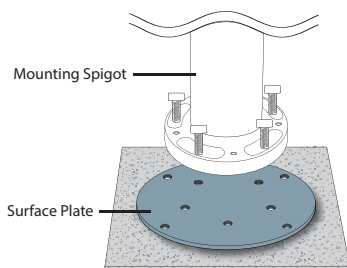

SURFACE PLATE

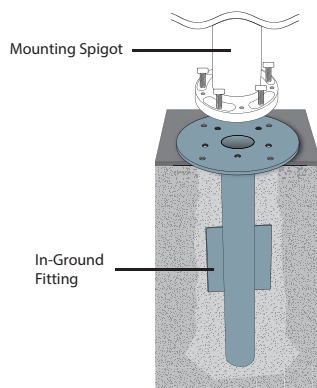

IN-GROUND ANCHOR



PORTABLE BASE
Note: Requires concrete pavers (not supplied) for anchoring weight